

TRONICS TRON-316-6
3 PHASE 16 AMPS PLUG/SOCKET SET

ON SYSTEM

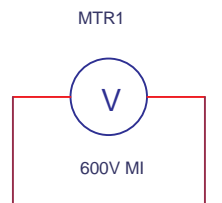

TERMINAL ON SOCKET

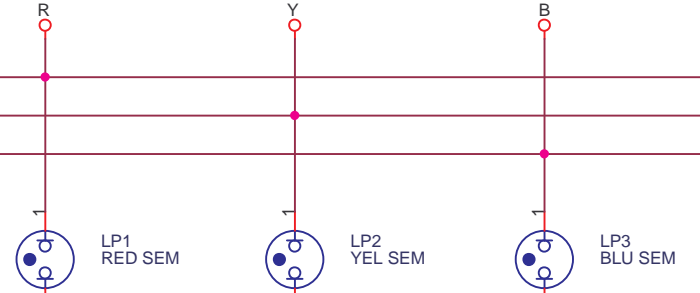
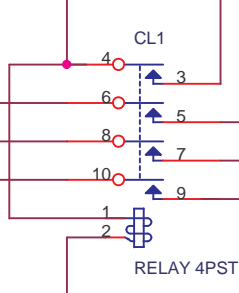
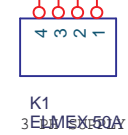
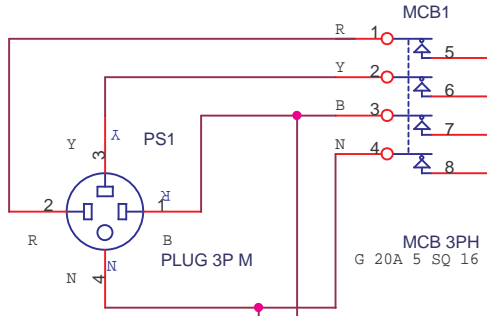
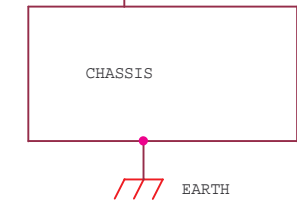
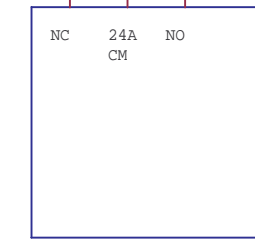
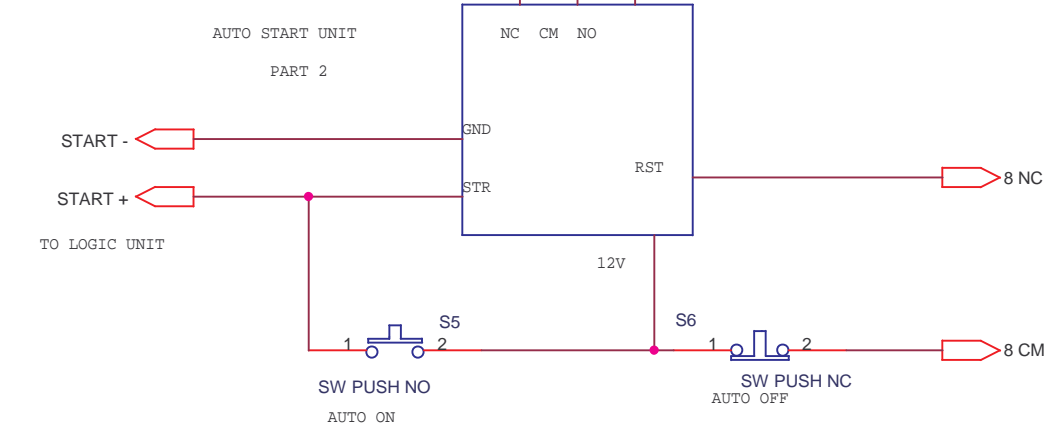
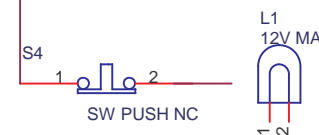
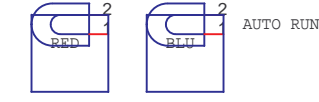
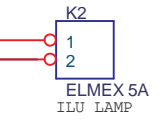
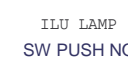
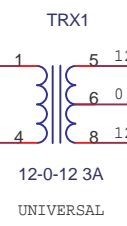
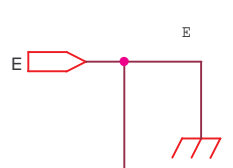

Title PANEL WIRING OF ULTI-HIVAC UNIT		
Size B	Document Number 98SPCT21.SCH	Rev 00
Date: Wednesday, August 20, 2003	Sheet 1	of 1